



"The best high voltage design solution"

J5 SERIES 5 WATT PROPORTIONAL HV DC/DC CONVERTERS

FEATURES



- ▶ **Customer Selects Output Voltage**
- ▶ Single Outputs to + or - 6000 Vdc
- ▶ Dual Outputs to +/- 3000 Vdc
- ▶ High Reliability
- ▶ Industry Standard Pinouts
- ▶ Wide Temperature Range (-25 to +85°C)
- ▶ 80 kHz Switching Frequency
- ▶ 3500 Vdc Output Isolation
- ▶ Continuous Short Circuit Protection

The J5 Series of miniature DC/DC converters offers a 3500 Vdc isolated high voltage output directly proportional to input voltage. They are available in industry standard pinouts. All models will tolerate a short circuit indefinitely.

ELECTRICAL SPECIFICATIONS

Voltage Accuracy	+/- 3%	Input Filter	Low ESR Capacitor
Line Regulation	Proportional	Efficiency	65% (typ.)
Load Regulation	< 10%	Short Circuit Protection	Continuous
Output Ripple	< 2% P-P	Switching Frequency	80 kHz
Startup Voltage	< 0.7Vdc	Output Isolation	3500 Vdc
		Input / Output Capacitance	< 30pF

GENERAL SPECIFICATIONS

Temp. Stability	+/-0.05%/°C	EMI/RFI	Shielded Version Available (<i>Suffix /S</i>)
Temp. (Operating , Case)	-25 to +85°C	Derating	None
Temp. (Storage)	-40 to +100°C	Cooling	Free-Air Convection
Humidity	0 to 95% (Non-Condensing)		

PHYSICAL SPECIFICATIONS

Dimensions	1.5 x 1.5 x 0.63 inches	Case Material	Black Phenolic
Weight	1.5 Oz		



"The best high voltage design solution"

J5 SERIES 5 WATT PROPORTIONAL HV DC/DC CONVERTERS

SINGLE OUTPUTS

REPRESENTATIVE MODEL LISTING							
MODEL NUMBER		INPUT SPECIFICATIONS			OUTPUT SPECIFICATIONS		
Non-RoHS	RoHS	VOLTAGE	NO LOAD	FULL LOAD	VOLTAGE	RIPPLE	CURRENT
J5-10	J5-10/Y	0V - 12Vdc	<90 mA	<700 mA	0V- 100Vdc	<0.5% (0.5V p-p)	50 mA
J5-20	J5-20/Y	0V - 12Vdc	<90 mA	<700 mA	0V- 200Vdc	<0.3% (0.6V p-p)	25 mA
J5-30	J5-30/Y	0V - 12Vdc	<90 mA	<700 mA	0V - 300Vdc	<0.2% (0.6V p-p)	16 mA
J5-40	J5-40/Y	0V - 12Vdc	<90 mA	<700 mA	0V- 400Vdc	<0.2% (0.8V p-p)	12.5 mA
J5-50	J5-50/Y	0V - 12Vdc	<90 mA	<720 mA	0V - 500Vdc	<0.1% (0.5V p-p)	10 mA
J5-60	J5-60/Y	0V - 12Vdc	<90 mA	<720 mA	0V- 600Vdc	<0.1% (0.6V p-p)	8.3 mA
J5-80	J5-80/Y	0V - 12Vdc	<110 mA	<720 mA	0V- 800Vdc	<0.1% (0.8V p-p)	6.3 mA
J5-100	J5-100/Y	0V - 12Vdc	<120 mA	<720 mA	0V- 1kVdc	<0.1% (1V p-p)	5.0 mA
J5-120	J5-120/Y	0V - 12Vdc	<120 mA	<730 mA	0V- 1.2kVdc	<0.1% (1.2V p-p)	4.2 mA
J5-140	J5-140/Y	0V - 12Vdc	<120 mA	<730 mA	0V- 1.4kVdc	<0.5% (7V p-p)	3.6 mA
J5-150	J5-150/Y	0V - 12Vdc	<120 mA	<730 mA	0V - 1.5kVdc	<0.5% (7.5V p-p)	3.3 mA
J5-160	J5-160/Y	0V - 12Vdc	<120 mA	<730 mA	0V- 1.6kVdc	<0.5% (8V p-p)	3.1 mA
J5-180	J5-180/Y	0V - 12Vdc	<120 mA	<730 mA	0V- 1.8kVdc	<0.5% (9V p-p)	2.8 mA
J5-200	J5-200/Y	0V - 12Vdc	<120 mA	<730 mA	0V- 2kVdc	<0.5% (10V p-p)	2.5 mA
J5-220	J5-220/Y	0V - 12Vdc	<130 mA	<730 mA	0V- 2.2kVdc	<0.5% (11V p-p)	2.3 mA
J5-240	J5-240/Y	0V - 12Vdc	<130 mA	<730 mA	0V- 2.4kVdc	<0.5% (12V p-p)	2.1 mA
J5-250	J5-250/Y	0V - 12Vdc	<130 mA	<740 mA	0V - 2.5kVdc	<0.5% (12.5V p-p)	2.0 mA
J5-260	J5-260/Y	0V - 12Vdc	<130 mA	<740 mA	0V - 2.6kVdc	<0.5% (13V p-p)	1.9 mA
J5-280	J5-280/Y	0V - 12Vdc	<130 mA	<740 mA	0V- 2.8kVdc	<0.5% (14V p-p)	1.8 mA
J5-300	J5-300/Y	0V - 12Vdc	<130 mA	<740 mA	0V - 3kVdc	<0.5% (15V p-p)	1.7 mA
J5-400	J5-400/Y	0V - 12Vdc	<140 mA	<750 mA	0V - 4kVdc	<1% (40V p-p)	1.25 mA
J5-500	J5-500/Y	0V - 12Vdc	<150 mA	<760 mA	0V - 5kVdc	<2% (100V p-p)	1.0 mA
J5-600	J5-600/Y	0V - 12Vdc	<150 mA	<760 mA	0V- 6kVdc	<2% (120V p-p)	0.83 mA



"The best high voltage design solution"

J5 SERIES 5 WATT PROPORTIONAL HV DC/DC CONVERTERS

DUAL OUTPUTS

REPRESENTATIVE MODEL LISTING							
MODEL NUMBER		INPUT SPECIFICATIONS			OUTPUT SPECIFICATIONS		
Non-RoHs	RoHs	VOLTAGE	NO LOAD	FULL LOAD	VOLTAGE	RIPPLE	CURRENT
J5-D5	J5-D5/Y	0V - 12Vdc	<90 mA	<700 mA	0V - +/-50Vdc	<1% (0.5V p-p)	50 mA
J5-D10	J5-D10/Y	0V - 12Vdc	<90 mA	<700 mA	0V - +/-100Vdc	<0.6% (0.6V p-p)	25 mA
J5-D15	J5-D15/Y	0V - 12Vdc	<90 mA	<700 mA	0V - +/-150Vdc	<0.4% (0.6V p-p)	16 mA
J5-D20	J5-D20/Y	0V - 12Vdc	<90 mA	<700 mA	0V - +/-200Vdc	<0.4% (0.8V p-p)	12.5 mA
J5-D25	J5-D25/Y	0V - 12Vdc	<90 mA	<720 mA	0V - +/-250Vdc	<0.2% (0.5V p-p)	10 mA
J5-D30	J5-D30/Y	0V - 12Vdc	<90 mA	<720mA	0V - +/-300Vdc	<0.2% (0.6V p-p)	8.3 mA
J5-D50	J5-D50/Y	0V - 12Vdc	<120 mA	<720 mA	0V - +/-500Vdc	<0.2% (1V p-p)	5.0 mA
J5-D60	J5-D60/Y	0V - 12Vdc	<120 mA	<730 mA	0V - +/-600Vdc	<0.2% (1.2V p-p)	4.2 mA
J5-D75	J5-D75/Y	0V - 12Vdc	<120 mA	<730 mA	0V - +/-750Vdc	<1% (7.5V p-p)	3.3 mA
J5-D100	J5-D100/Y	0V - 12Vdc	<120 mA	<730 mA	0V - +/-1kVdc	<1% (10V p-p)	2.5 mA
J5-D125	J5-D125/Y	0V - 12Vdc	<130 mA	<740 mA	0V - +/-1.25kVdc	<1% (12.5V p-p)	2.0 mA
J5-D150	J5-D150/Y	0V - 12Vdc	<130 mA	<740 mA	0V - +/-1.5kVdc	<1% (15V p-p)	1.7 mA
J5-D200	J5-D200/Y	0V - 12Vdc	<140 mA	<750 mA	0V - +/-2kVdc	<2% (40V p-p)	1.25 mA
J5-D250	J5-D250/Y	0V - 12Vdc	<150 mA	<760 mA	0V - +/-2.5kVdc	<4% (100V p-p)	1.0 mA
J5-D300	J5-D300/Y	0V - 12Vdc	<150 mA	<760 mA	0V - +/-3kVdc	<4% (120V p-p)	0.83 mA

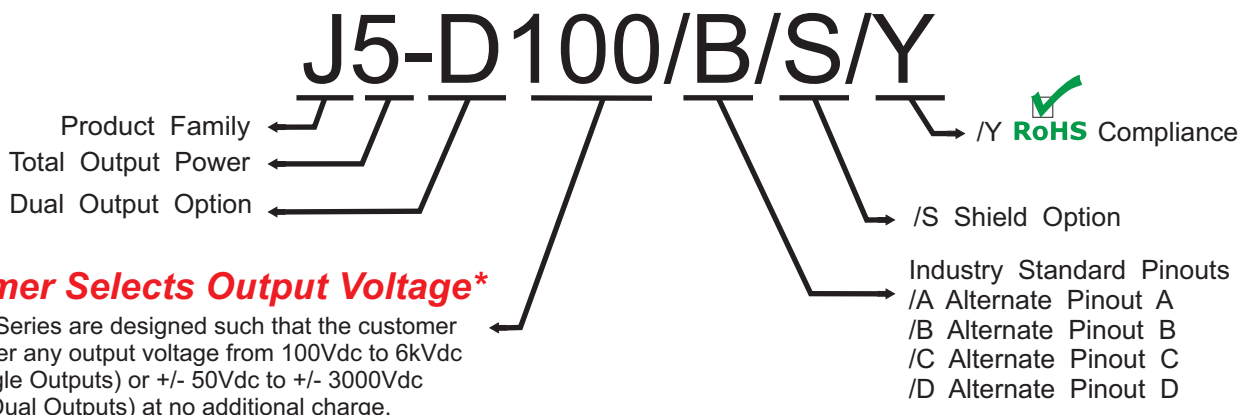

***ACTUAL OUTPUT VOLTAGE IS 10X**

NOTE:
 Ripple on dual output units are measured between the positive and negative output pins.



"The best high voltage design solution"

J5 SERIES 5 WATT PROPORTIONAL HV DC/DC CONVERTERS

STANDARD PINOUT

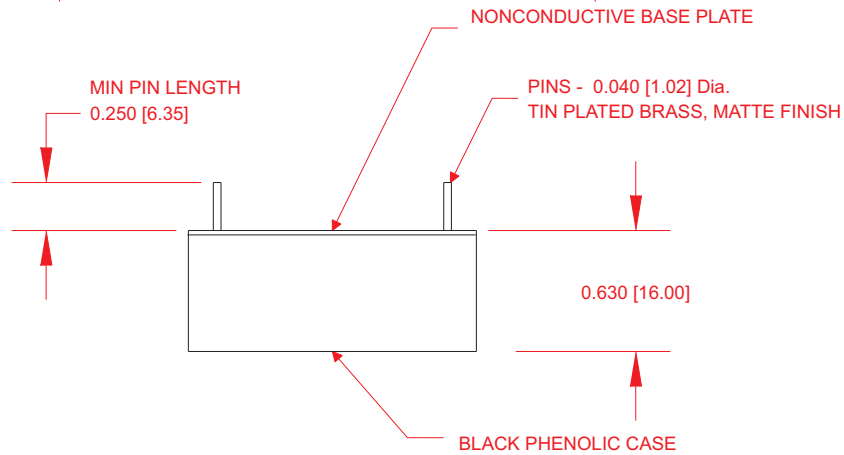
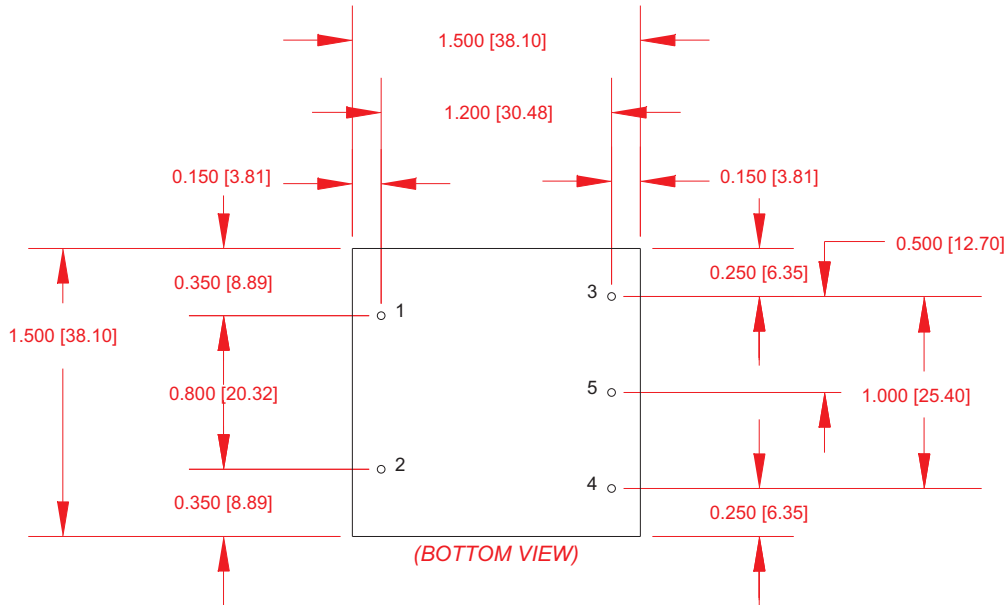

PIN #	STANDARD	
	Single	Dual
1	+ Input	+ Input
2	- Input	- Input
3	- Output	- Output
4	+ Output	+ Output
5	No Pin	Com

*Dimensions are in Inches
[Metric equivalents in brackets]*



"The best high voltage design solution"

J5 SERIES 5 WATT PROPORTIONAL HV DC/DC CONVERTERS

ALTERNATE PINOUT (/B) *(Previously referred to as /A Pinout)*

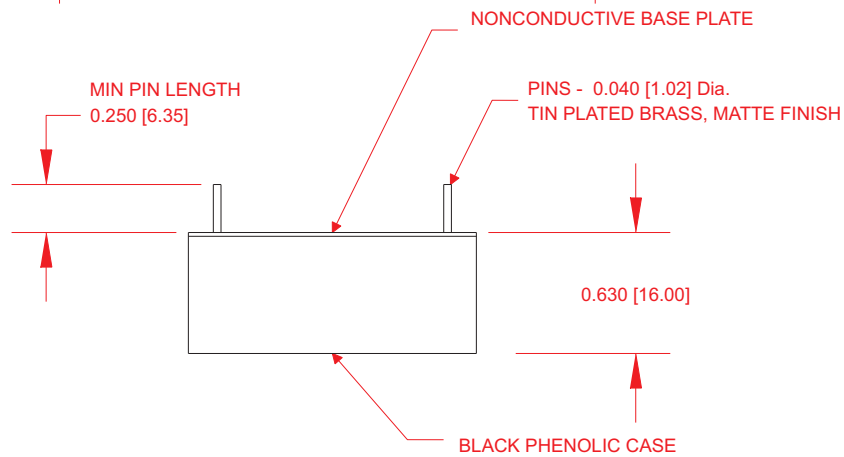
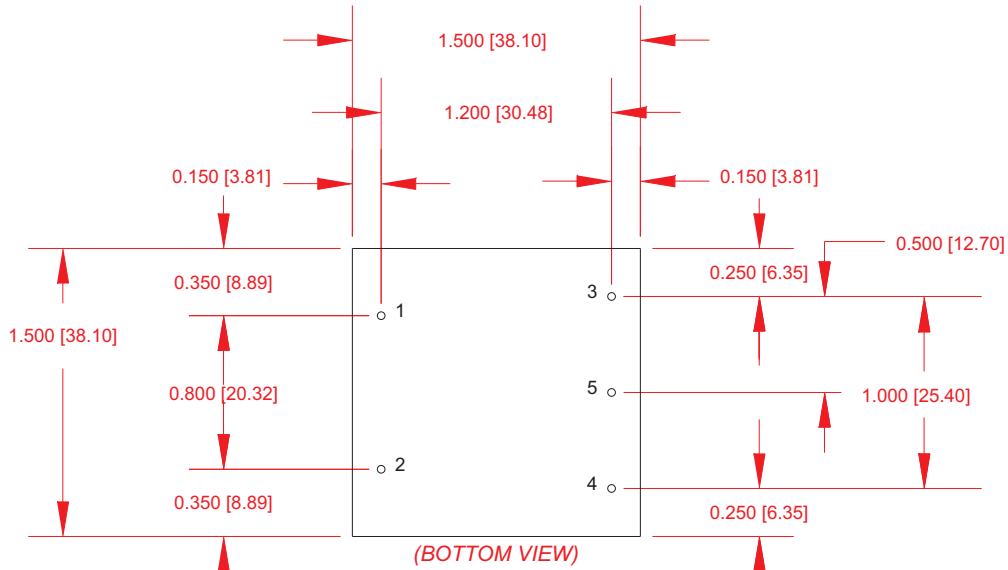

PIN #	SINGLE	DUAL
1	+ Input	+ Input
2	- Input	- Input
3	+ Output	+ Output
4	- Output	- Output
5	No Pin	Com

*Dimensions are in Inches
[Metric equivalents in brackets]*



"The best high voltage design solution"

J5 SERIES 5 WATT PROPORTIONAL HV DC/DC CONVERTERS

ALTERNATE PINOUT (/C)

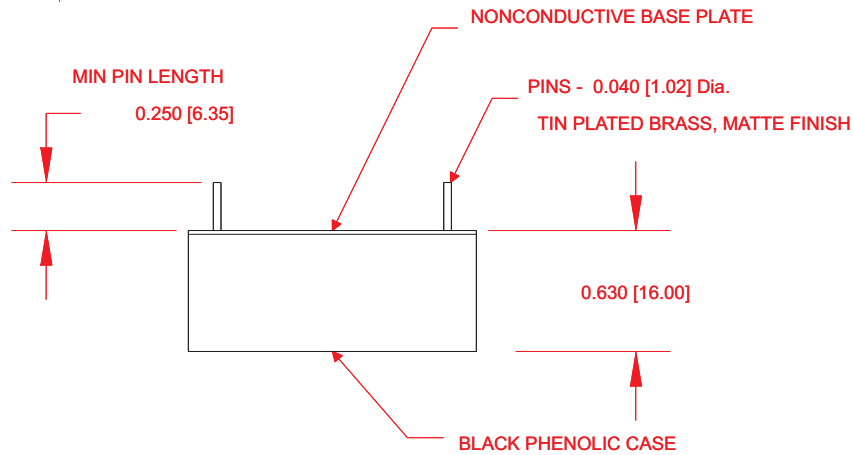
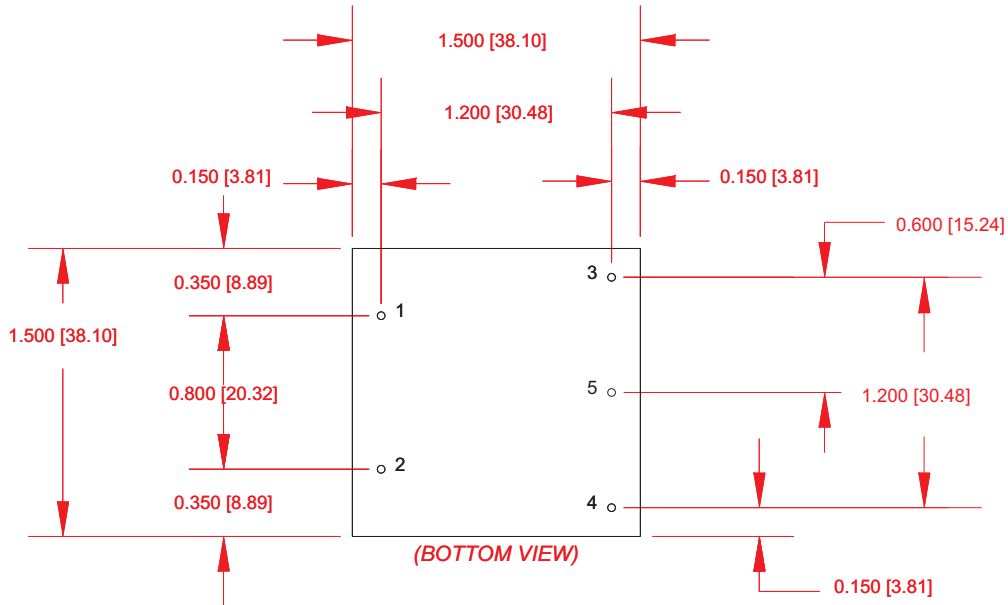

PIN #	SINGLE	DUAL
1	+ Input	+ Input
2	- Input	- Input
3	+ Output	+ Output
4	- Output	- Output
5	No Pin	Com

*Dimensions are in Inches
[Metric equivalents in brackets]*



"The best high voltage design solution"

J5 SERIES 5 WATT PROPORTIONAL HV DC/DC CONVERTERS

ALTERNATE PINOUT (/D)

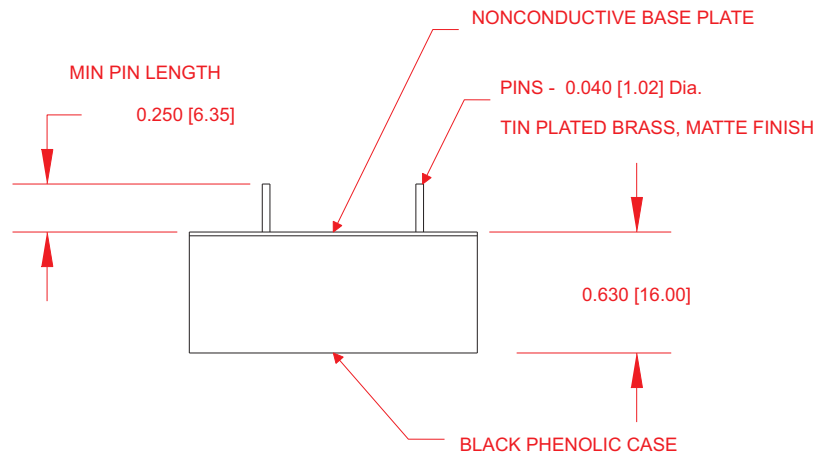
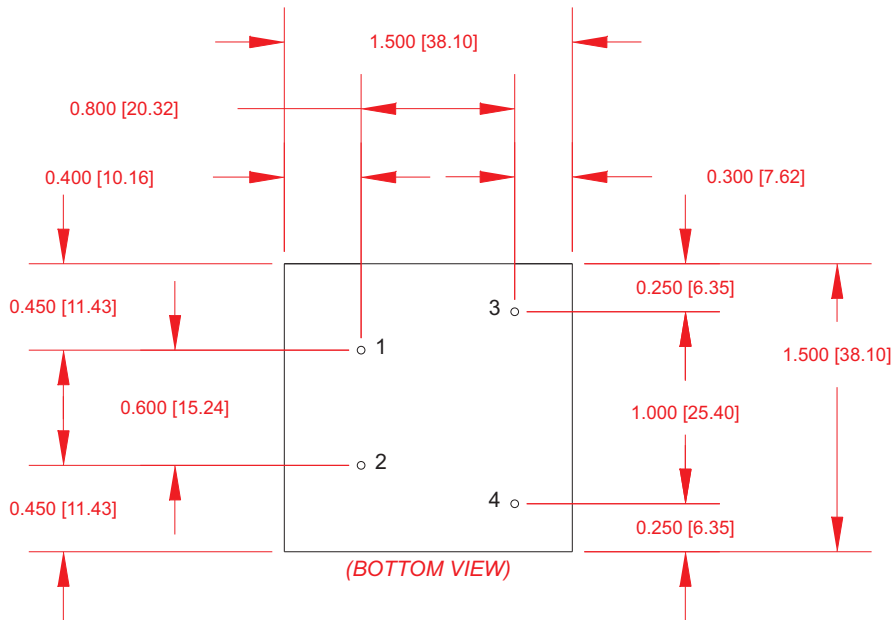

PIN #	SINGLE OUTPUTS ONLY
1	+ Input
2	- Input
3	- Output
4	+ Output

*Dimensions are in Inches
[Metric equivalents in brackets]*



"The best high voltage design solution"

J5 SERIES 5 WATT PROPORTIONAL HV DC/DC CONVERTERS

ALTERNATE PINOUT (/E)

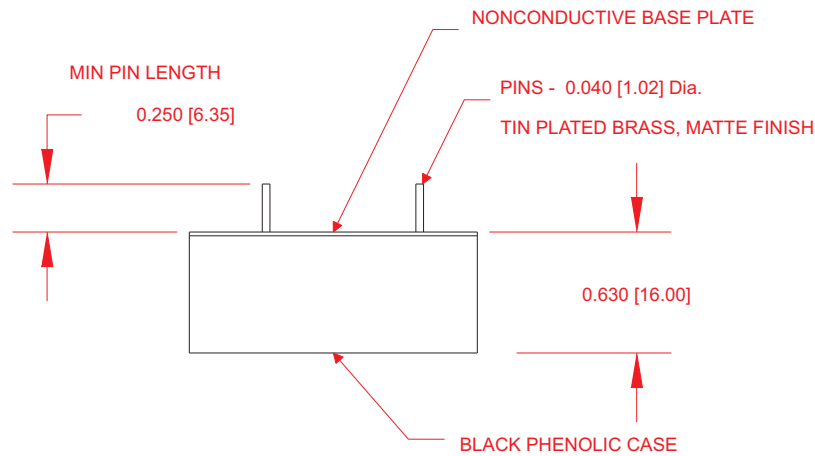
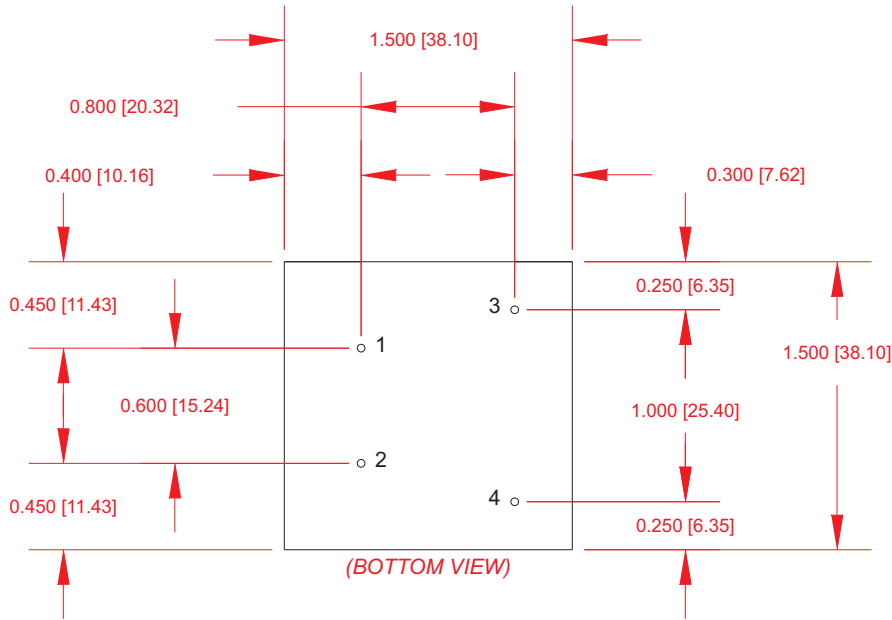

PIN #	SINGLE OUTPUTS ONLY
1	+ Input
2	- Input
3	+Output
4	- Output

*Dimensions are in Inches
[Metric equivalents in brackets]*



"The best high voltage design solution"

J5 SERIES 5 WATT PROPORTIONAL HV DC/DC CONVERTERS

SHIELD OPTION (/S)

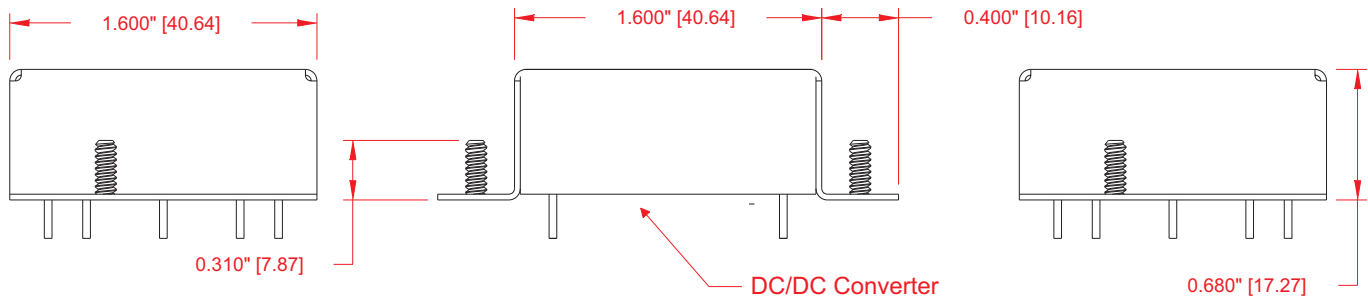
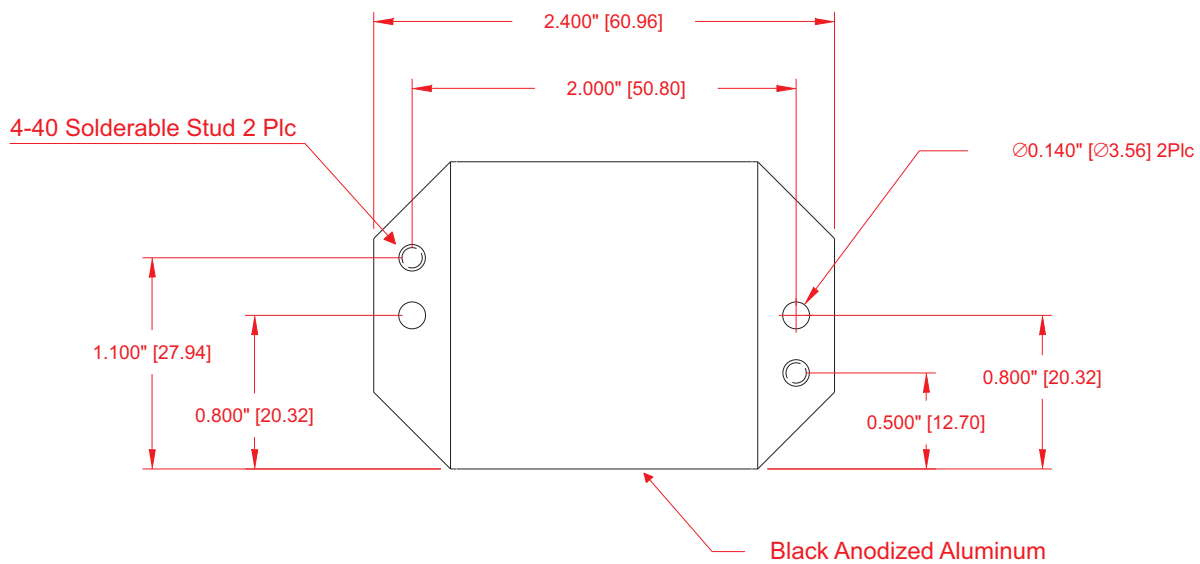



"The best high voltage design solution"

J5 SERIES 5 WATT PROPORTIONAL HV DC/DC CONVERTERS

APPLICATION NOTES

INPUT AND OUTPUT IMPEDANCE

The J5 Series of power converters have been designed to be stable with no external capacitors when used in low inductance input and output circuits. However, in some applications, the inductance associated with the distribution from the power source to the input of the converter can affect the stability of the converter. The addition of a 100 μ F electrolytic capacitor with an ESR <1 Ohm across the input helps ensure stability of the converter. In some applications, the user may need to use decoupling capacitance at the load.

SHORT CIRCUIT PROTECTION

The J5 Series is equipped with short circuit protection. The converter will fold-back the input power whenever a short circuit is applied to its output and automatically recover after the overload condition is removed.

ISOLATION

The output of the J5 Series is galvanically isolated from the input, capacitance is < 30pF and resistance is > 10G Ohm. For dual output units Isolation is from Com output pin (5) and -Input (2).

RIPPLE AND NOISE

Figure below shows a typical output voltage ripple waveform, measured at full rated load current with no additional output filtering. External low ESR capacitors may be added across output to further reduce ripple.

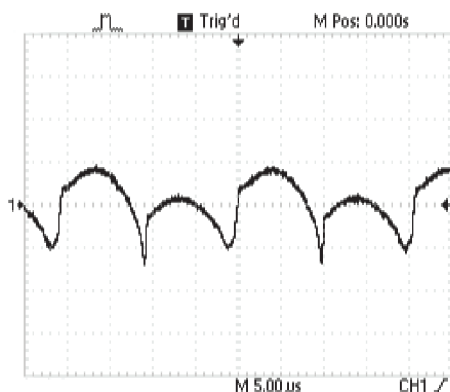

STARTUP TRANSIENT

Figure below shows a typical output voltage during turn-on, measured at no load current with no additional output filtering.

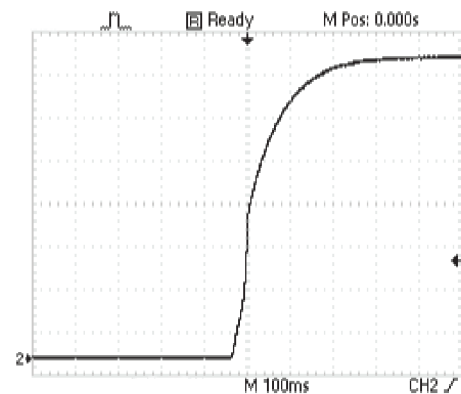
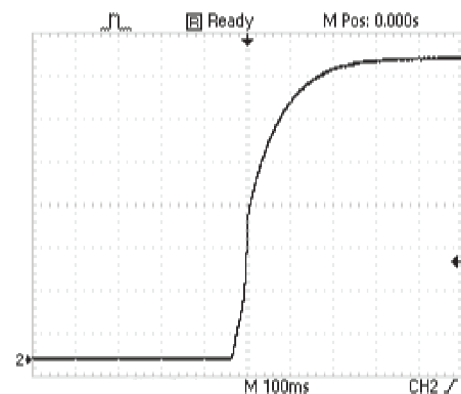

Figure below shows a typical output voltage during turn-on, measured at full rated load current with no additional output filtering.





"The best high voltage design solution"

J5 SERIES 5 WATT PROPORTIONAL HV DC/DC CONVERTERS

APPLICATION NOTES

INRUSH CURRENT

The inrush current of the J5 Series has been kept as low as possible. However, a series resistor may be inserted in the input line to limit this current further.

LOAD TRANSIENT

Figure below shows a typical output voltage response, measured during a transition from full rated load current to no load current with no additional output filtering.

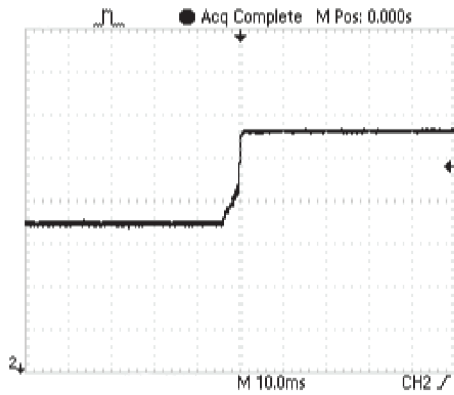
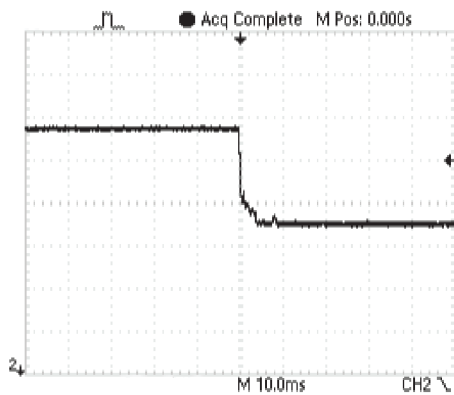

Figure below shows a typical output voltage response, measured during a transition from no load current to full rated load current with no additional output filtering.



CONNECTION IN PARALLEL

The figures below shows how to connect outputs of several units with equal nominal output voltage in parallel with the use of oring diodes.

POSITIVE OUTPUT

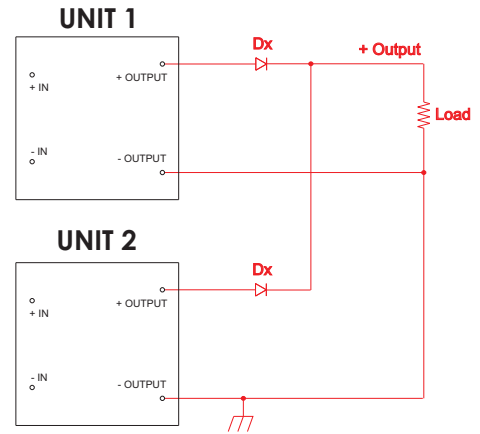

NEGATIVE OUTPUT

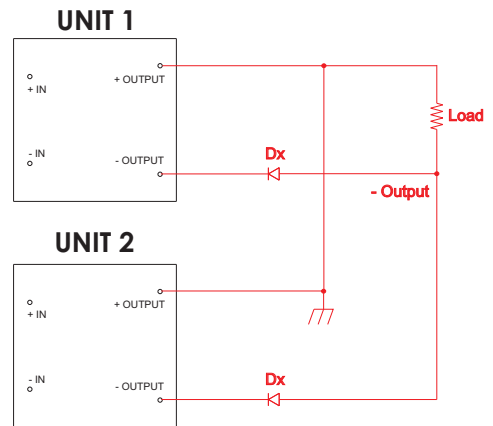

NOTE:
The ratings of Dx should be 1.5 times the maximum current and voltage expected in each branch.



"The best high voltage design solution"

J5 SERIES 5 WATT PROPORTIONAL HV DC/DC CONVERTERS

CONNECTION IN SERIES

Figures below shows how to connect multiple outputs in series with the use of shunt diodes, taking into consideration that the highest achieved output voltage should remain below the rated isolation voltage.

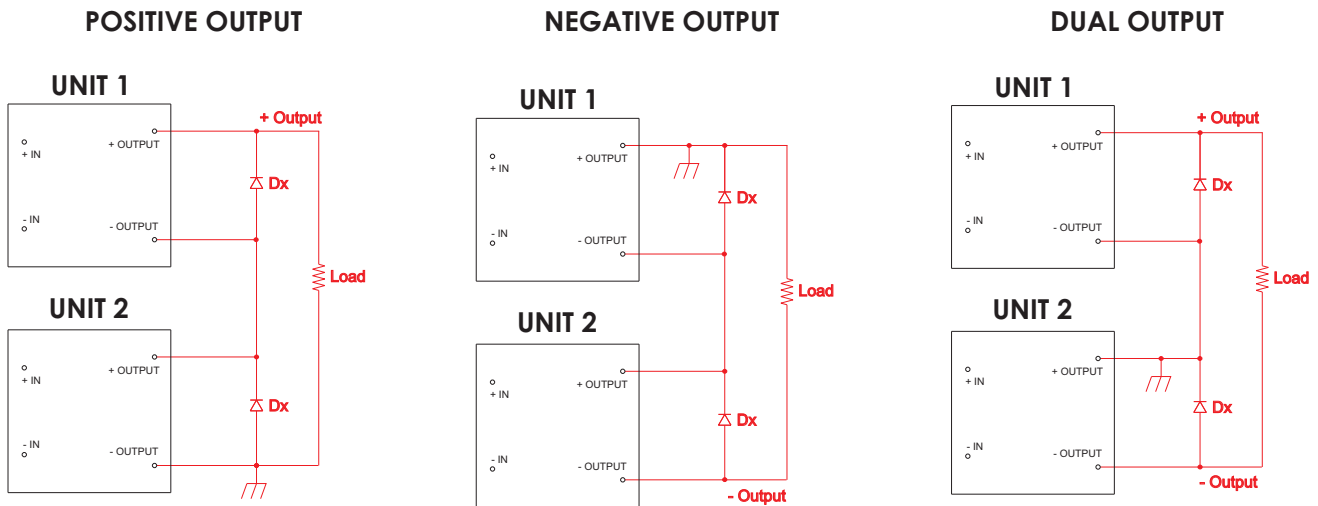

NOTE:
The ratings of Dx should be 1.5 times the maximum current and voltage expected in each branch.



"The best high voltage design solution"

J5 SERIES 5 WATT PROPORTIONAL HV DC/DC CONVERTERS

APPLICATION NOTES

POSITIVE OR NEGATIVE OUTPUTS

Isolated DC-DC voltage converters can provide positive or negative voltages from a single device.

Isolated DC-DC converters may also be used with either a positive or a negative input voltage source, as long as the relative polarity of the input to the device is maintained.

The figures below show the various polarity combinations and how to connect the converter to provide them relative to ground.

CONNECTIONS FOR DUAL OUTPUTS

Isolation on a dual output converter is from Com output pin (5) and -Input (2) and therefore ground connection on the output is to Com pin only.

The figures below shows how to power a dual output converter with either a positive or a negative input voltage source.

POSITIVE SOURCE WITH A POSITIVE OUTPUT

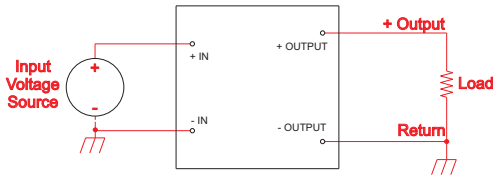

POSITIVE VOLTAGE SOURCE

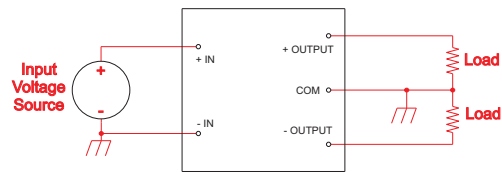

POSITIVE SOURCE WITH A NEGATIVE OUTPUT

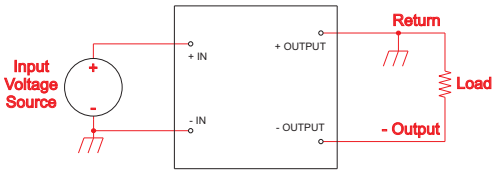

NEGATIVE VOLTAGE SOURCE

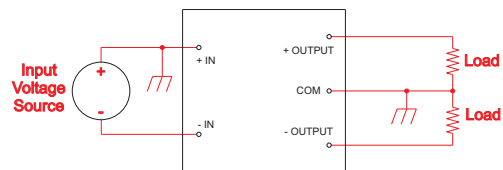

NEGATIVE SOURCE WITH A POSITIVE OUTPUT

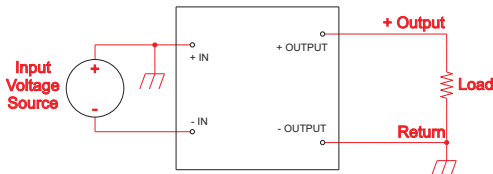

NEGATIVE SOURCE WITH A NEGATIVE OUTPUT

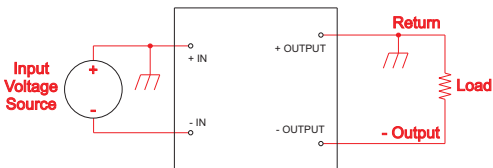

NOTE:

The (- In) must be kept negative with respect to the (+In) pin. If this polarity is reversed, permanent damage to the converter may occur.



"The best high voltage design solution"

J5 SERIES 5 WATT PROPORTIONAL HV DC/DC CONVERTERS

APPLICATION NOTES

CLEANING AGENTS

In order to avoid possible damage, any penetration of cleaning fluids must be prevented, since the power supplies are not hermetically sealed.

NUCLEAR AND MEDICAL APPLICATIONS

American Power Design products are not designed, intended for use in, or authorized for use as critical components in life support systems, equipment used in hazardous environments, or nuclear control systems without the express written consent of American Power Design, Inc.

TECHNICAL REVISIONS

The appearance of products, including safety agency certifications pictured on labels, may change depending on the date manufactured. Specifications are subject to change without notice.

SAFETY REQUIREMENTS

The converters are designed to meet North American and International safety regulatory requirements per UL 60950-1/CSA 22.2 No. 60950-1-07 Second Edition, IEC 60950-1:2005, and EN 60950-1:2006. Basic Insulation is provided between input and output. To comply with safety agencies requirements, an input line fuse must be used external to the converter. The table below provides the recommended fuse rating for use with this family of products.

Input Voltage Range	Fuse Rating
0-12Vdc	1A

If one input fuse is used for a group of modules, the maximum fuse rating should not exceed 10A.

WARRANTY

All products manufactured by American Power Design, Inc. (APD) are warranted to be free of defects due to material or workmanship for a period of one year from date of shipment. At our option, APD will repair or replace any non-conforming product.

APD expressly disclaims any liability for consequential or incidental damages resulting from the use or misuse of its products by the purchaser or others.

This warranty is in lieu of all warranties expressed or implied, including the warranties of merchantability. No other warranties, obligations, or liabilities are expressed or implied.

All products being returned for repair require a return material authorization(RMA) assigned by APD prior to return shipment.