



C75 SERIES 75 WATT DC/DC CONVERTERS

FEATURES



- ▶ **Customer Selects Output Voltage**
- ▶ Outputs to 28 Vdc
- ▶ Wide Input Ranges
(10-20Vdc, 18-36Vdc, 20-60Vdc, 36-72Vdc)
- ▶ Excellent Line & Load Regulation
- ▶ 500 Vdc Output Isolation
- ▶ Continuous Short Circuit Protection
- ▶ Thermal Shutdown (*Self-Resetting*)
- ▶ Available in Chassis Mount

The C75 Series of DC/DC converters offers a single output to 28Vdc and 500Vdc of isolation. They are available in either PC or Chassis mount configurations. Their rugged enclosure, low output ripple, and excellent regulation characteristics make them ideally suited for harsh environment applications that demand a high degree of performance. All models will tolerate a short circuit indefinitely.

ELECTRICAL SPECIFICATIONS

Voltage Accuracy	+/-1%	Input Filter	PI Network
Line Regulation	+/- 0.1%	Efficiency	87% (typ.)
Load Regulation	+/- 0.1%	Short Circuit Protection	Continuous
Output Ripple	< 100mV P-P	Switching Frequency	130 kHz
Output Trim	+/-10%	Output Isolation	500 Vdc
		Input / Output Capacitance	< 1300pF

GENERAL SPECIFICATIONS

Temp. Stability	+/-0.02%/°C	Logic Shutdown	Logic 0 (off)
Temp. (Operating , Case)	-40 to +85°C	EMI/RFI	Six Sided Shield
Temp. (Storage)	-40 to +125°C	Derating	None
		Cooling	Free-Air Convection or Forced Air
		Thermal Shut Down	100°C/+/- 5°C <i>(Self-Resetting)</i>

PHYSICAL SPECIFICATIONS

Dimensions	2.75 x 4.8 x 0.92 inches	Case Material	Black Coated Metal <i>(With Non-Conductive Base Plate)</i>
Weight	13.5 Oz		



C75 SERIES 75 WATT DC/DC CONVERTERS

REPRESENTATIVE MODEL LISTING									
OUTPUT SPECIFICATIONS		MODEL NUMBER / INPUT RANGE							
		10-20VDC		18-36VDC		20-60VDC		36-72VDC	
VOLTAGE	CURRENT	Non-RoHs	RoHs	Non-RoHs	RoHs	Non-RoHs	RoHs	Non-RoHs	RoHs
5 Vdc	15 A	C75-5	C75-5/Y	C75-5/A	C75-5/A/Y	C75-5/B	C75-5/B/Y	C75-5/C	C75-5/C/Y
6 Vdc	12.5 A	C75-6	C75-6/Y	C75-6/A	C75-6/A/Y	C75-6/B	C75-6/B/Y	C75-6/C	C75-6/C/Y
9 Vdc	8.3 A	C75-9	C75-9/Y	C75-9/A	C75-9/A/Y	C75-9/B	C75-9/B/Y	C75-9/C	C75-9/C/Y
12 Vdc	6.2 A	C75-12	C75-12/Y	C75-12/A	C75-12/A/Y	C75-12/B	C75-12/B/Y	C75-12/C	C75-12/C/Y
15 Vdc	5 A	C75-15	C75-15/Y	C75-15/A	C75-15/A/Y	C75-15/B	C75-15/B/Y	C75-15/C	C75-15/C/Y
18 Vdc	4.2 A	C75-18	C75-18/Y	C75-18/A	C75-18/A/Y	C75-18/B	C75-18/B/Y	C75-18/C	C75-18/C/Y
21 Vdc	3.6 A	C75-21	C75-21/Y	C75-21/A	C75-21/A/Y	C75-21/B	C75-21/B/Y	C75-21/C	C75-21/C/Y
24 Vdc	3.1 A	C75-24	C75-24/Y	C75-24/A	C75-24/A/Y	C75-24/B	C75-24/B/Y	C75-24/C	C75-24/C/Y
28 Vdc	2.7 A	C75-28	C75-28/Y	C75-28/A	C75-28/A/Y	C75-28/B	C75-28/B/Y	C75-28/C	C75-28/C/Y

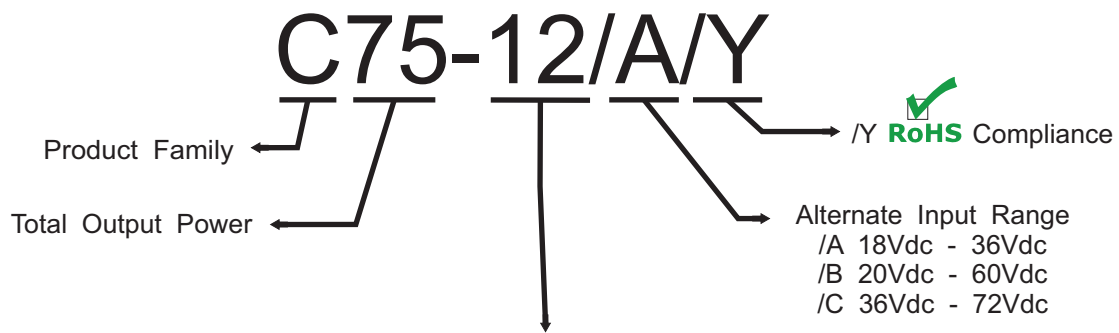

Customer Selects Output Voltage

The C75 Series are designed such that the customer may order any output voltage from 5Vdc to 28Vdc at no additional charge.



C75 SERIES 75 WATT DC/DC CONVERTERS

STANDARD PC MOUNT

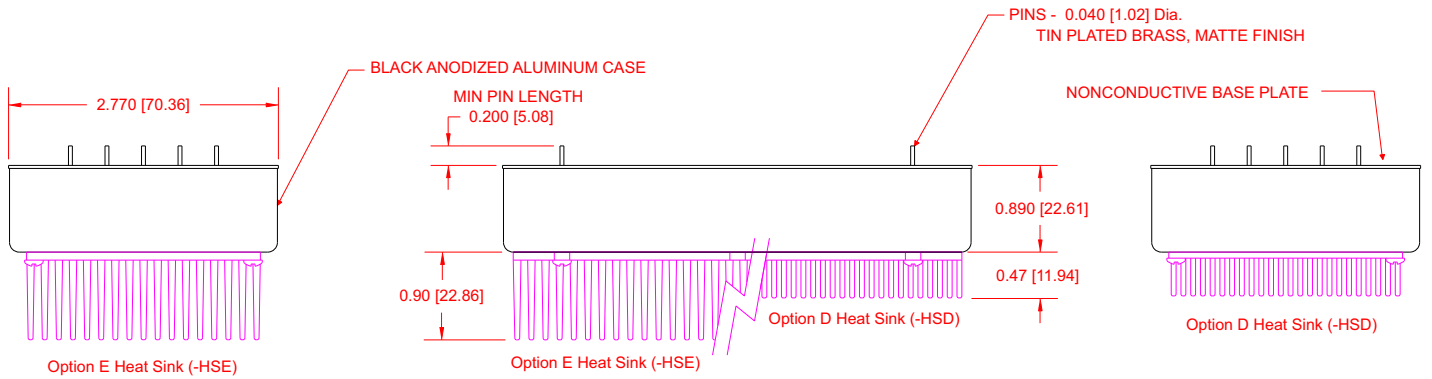
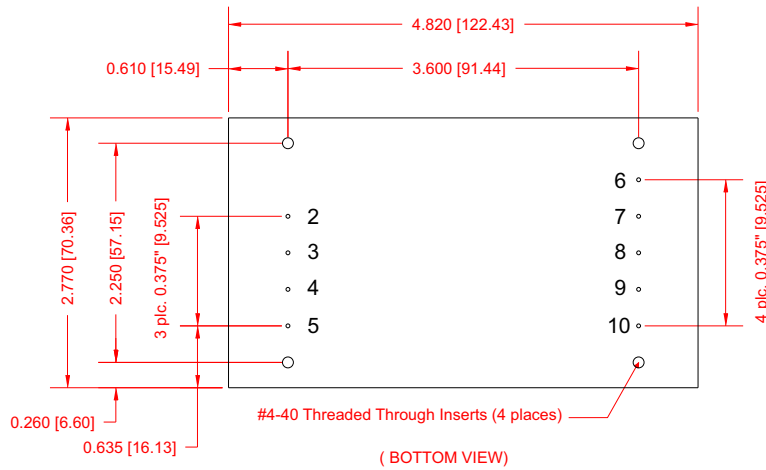

PIN #	FUNCTION	PIN #	FUNCTION
1	No Pin	6	-V Out
2	- Input	7	+ V Out
3	+ Input	8	- Sense
4	On / Off	9	Trim
5	Case	10	+ Sense

*Dimensions are in Inches
[Metric equivalents in brackets]*



C75 SERIES 75 WATT DC/DC CONVERTERS

-TS CHASSIS MOUNT OPTION

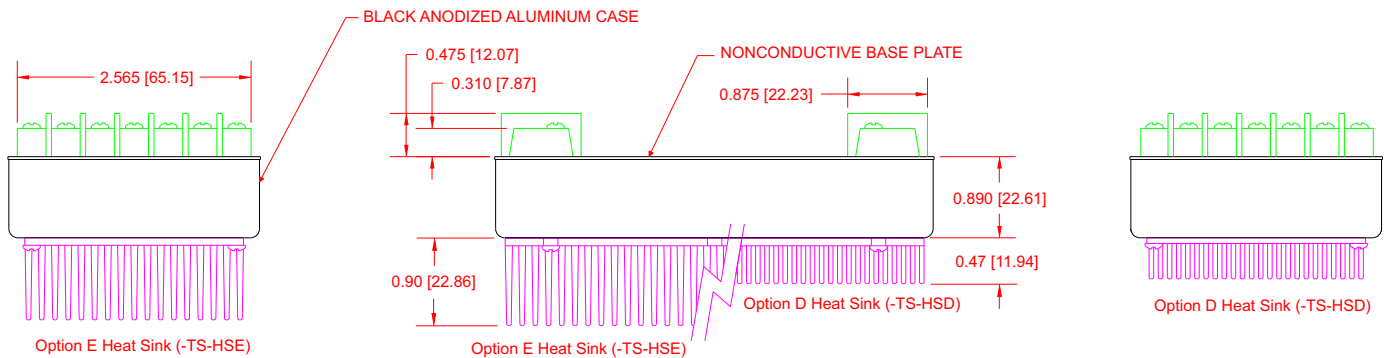
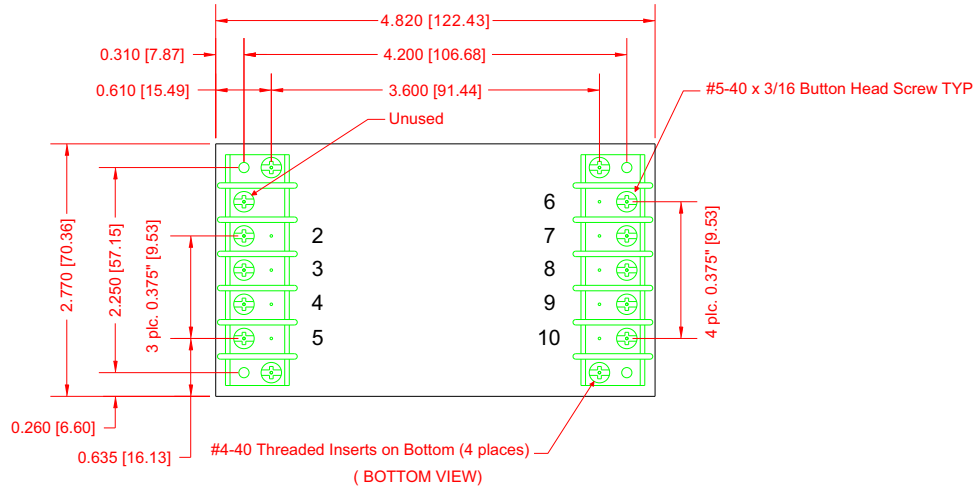

PIN #	FUNCTION	PIN #	FUNCTION
1	No Pin	6	-V Out
2	- Input	7	+ V Out
3	+ Input	8	- Sense
4	On / Off	9	Trim
5	Case	10	+ Sense

*Dimensions are in Inches
[Metric equivalents in brackets]*



C75 SERIES 75 WATT DC/DC CONVERTERS

APPLICATION NOTES

INPUT AND OUTPUT IMPEDANCE

The C75 Series of power converters have been designed to be stable with no external capacitors when used in low inductance input and output circuits. However, in some applications, the inductance associated with the distribution from the power source to the input of the converter can affect the stability of the converter. The addition of a 100 μ F electrolytic capacitor with an ESR <1 Ohm across the input helps ensure stability of the converter. In many applications, the user has to use decoupling capacitance at the load.

SHORT CIRCUIT PROTECTION

The C75 Series is equipped with short circuit protection. The converter will fold-back the input power whenever a short circuit is applied to its output and automatically recover after the overload condition is removed.

ISOLATION

The output of the C75 Series is galvanically isolated from both the input and case, capacitance is < 1300pF and resistance is > 10G Ohm. The figure below shows the internal RC network that connects the Case (Pin 5) to Input(-) (Pin 2). This aides in reducing unwanted noise.

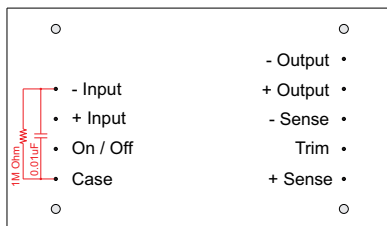

INRUSH CURRENT

The inrush current of the C75 Series has been kept as low as possible. However, a series resistor may be inserted in the input line to limit this current further.

REMOTE SENSING

The C75 Series is equipped with remote sensing, this feature compensates for voltage drops occurring between the output pins of the converter and the load. The SENSE(-) (Pin 8) and SENSE(+) (Pin 10) should be connected at the load or at the point where regulation is required.

The feedback through the sensing pins allows the converter to output a higher voltage at the output pins to compensate for the voltage drop on the connections between the converters output and the load. It will compensate for up to 0.5V drop between the converter and the load.

Because the sense leads carry minimal current, large traces on the end-user board are not required. However, sense traces should be located close to a ground plane to minimize system noise and insure optimum performance. When wiring discretely, twisted pair wires should be used to connect the sense lines to the load to reduce susceptibility to noise.

The figure below shows the correct method of installation using this option.

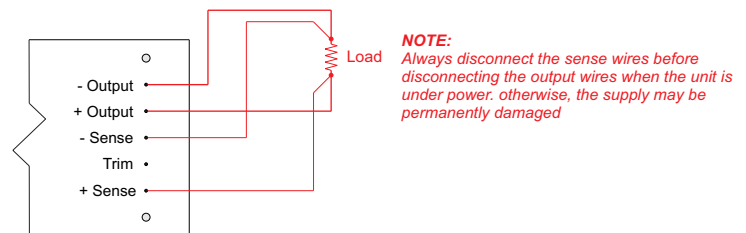

If remote sensing is not required, the SENSE(-) (Pin 8) must be connected to the Output(-) (Pin 6), and the SENSE(+) (Pin 10) must be connected to the Output(+) (Pin 7) to ensure the converter will regulate at the specified output voltage. If these connections are not made, the converter will deliver an output voltage that is slightly higher than the specified value.



C75 SERIES 75 WATT DC/DC CONVERTERS

APPLICATION NOTES

REMOTE ON/OFF CONTROL

The On/Off control (Pin 4) allows the user to shut down the converter mechanically or logically using a relay or a TTL or CMOS logic signal.

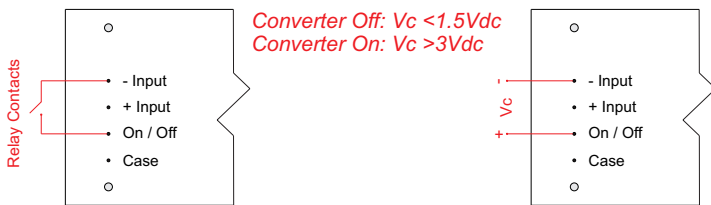

TRIM OUTPUT

The C75 Series is equipped with an output trim pin (Pin 9), this feature allows the user to adjust the output voltage up or down 10% using a fixed precision resistor or adjustable trim pot.

The figure below shows how to adjust the output voltage using a fixed precision resistor.

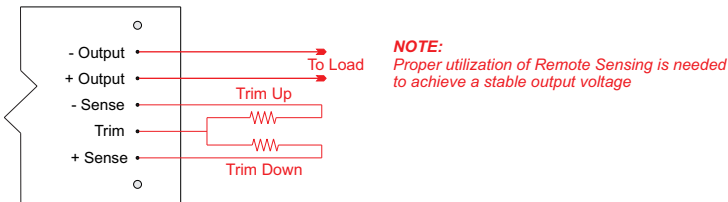

The figure below shows how to adjust the output voltage using an external Trim Pot.

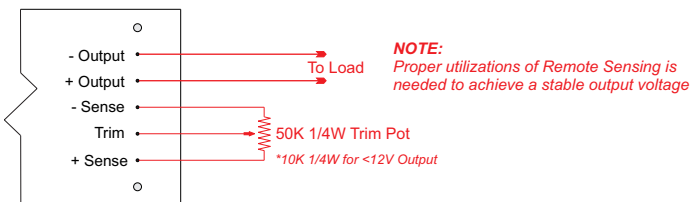

CONNECTION IN SERIES

Figure below shows how to connect multiple outputs in series with the use of shunt diodes, taking into consideration that the highest achieved output voltage should remain below the rated isolation voltage.

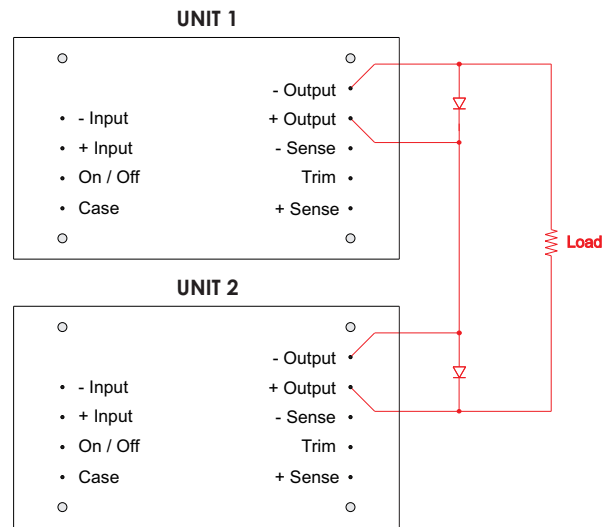

CONNECTION IN PARALLEL

The figure below show how to connect outputs of several units with equal nominal output voltage in parallel with the use of oring diodes.

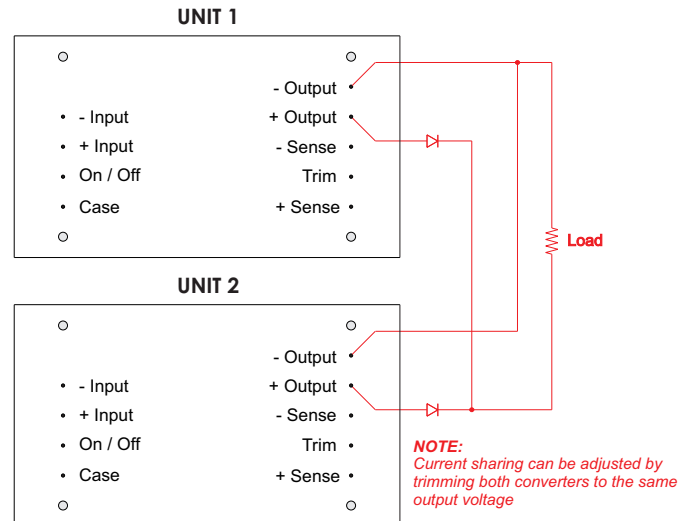



C75 SERIES 75 WATT DC/DC CONVERTERS

APPLICATION NOTES

LOAD TRANSIENT

Figure below shows a typical output voltage response, measured during a transition from full rated load current to no load current with no additional output filtering.

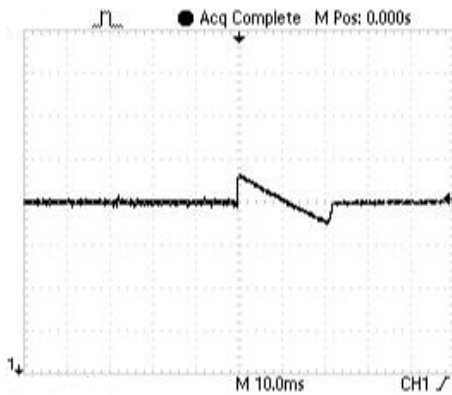
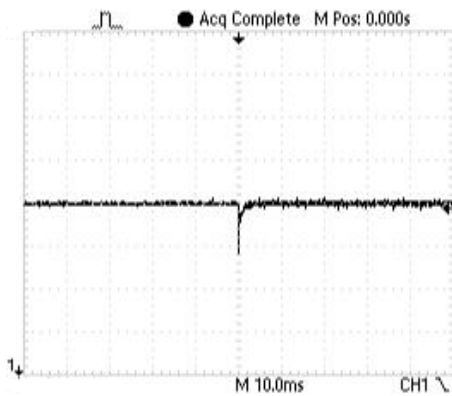

Figure below shows a typical output voltage response, measured during a transition from no load current to full rated load current with no additional output filtering.



STARTUP TRANSIENT

Figure below shows a typical output voltage during turn-on, measured at no load current with no additional output filtering.

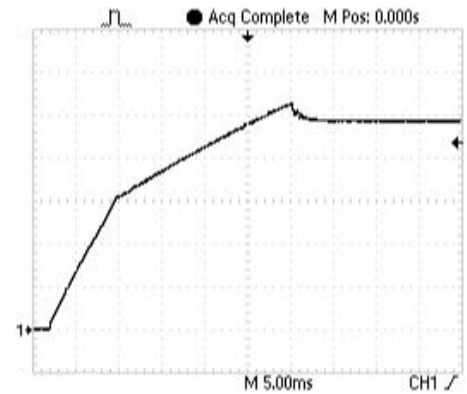
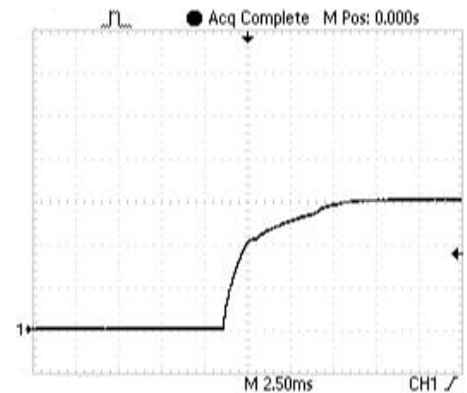

Figure below shows a typical output voltage during turn-on, measured at full rated load current with no additional output filtering.





C75 SERIES 75 WATT DC/DC CONVERTERS

APPLICATION NOTES

RIPPLE AND NOISE

Figure below shows a typical output voltage ripple waveform, measured with 20MHz bandwidth filter at full rated load current with no additional output filtering. External low ESR capacitors may be added across output to further reduce ripple.

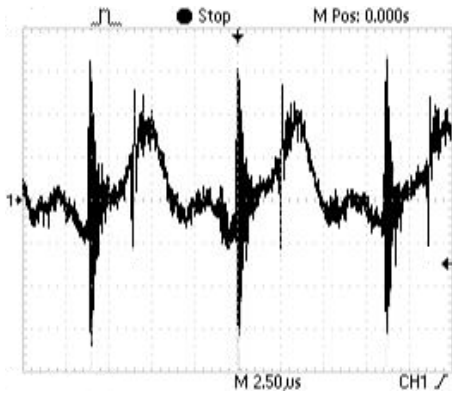

NUCLEAR AND MEDICAL APPLICATIONS

American Power Design products are not designed, intended for use in, or authorized for use as critical components in life support systems, equipment used in hazardous environments, or nuclear control systems without the express written consent of American Power Design, Inc.

WARRANTY

All products manufactured by American Power Design, Inc. (APD) are warranted to be free of defects due to material or workmanship for a period of one year from date of shipment. At our option, APD will repair or replace any non-conforming product.

APD expressly disclaims any liability for consequential or incidental damages resulting from the use or misuse of its products by the purchaser or others.

This warranty is in lieu of all warranties expressed or implied, including the warranties of merchantability. No other warranties, obligations, or liabilities are expressed or implied.

All products being returned for repair require a return material authorization(RMA) assigned by APD prior to return shipment.

CLEANING AGENTS

In order to avoid possible damage, any penetration of cleaning fluids must be prevented, since the power supplies are not hermetically sealed.

TECHNICAL REVISIONS

The appearance of products, including safety agency certifications pictured on labels, may change depending on the date manufactured. Specifications are subject to change without notice.

SAFETY REQUIREMENTS

The converters are designed to meet North American and International safety regulatory requirements per UL 60950-1/CSA 22.2 No. 60950-1-07 Second Edition, IEC 60950-1:2005, and EN 60950-1:2006. Basic Insulation is provided between input and output. To comply with safety agencies requirements, an input line fuse must be used external to the converter. The table below provides the recommended fuse rating for use with this family of products.

Input Voltage Range	Fuse Rating
10-20Vdc	15A
18-36Vdc	8A
20-60Vdc	7A
36-72Vdc	4A

If one input fuse is used for a group of modules, the maximum fuse rating should not exceed 20A.